

# **FileSource**®

Specialty Filing & Indexing Products



*... for Real Estate, Escrow, Mortgage & Medical Offices*

FALL 2007

## **MEDICAL~DENTAL VINYL FILING PRODUCTS**



[www.FileSource.com](http://www.FileSource.com)

# OUTGUIDES

Our most popular designs are the choice of professionals, from the small office to the largest of institutions. You get extra performance from the specially formulated 15 gauge rigid vinyl body and 12 gauge suede-clear pockets. Pockets have thumb-cuts, angle cuts and stress-relief contours to add to pocket life. Tabs are printed on both sides of the guides or debossed through at least one layer of clear and one layer of rigid material to make the "OUT" stand out.

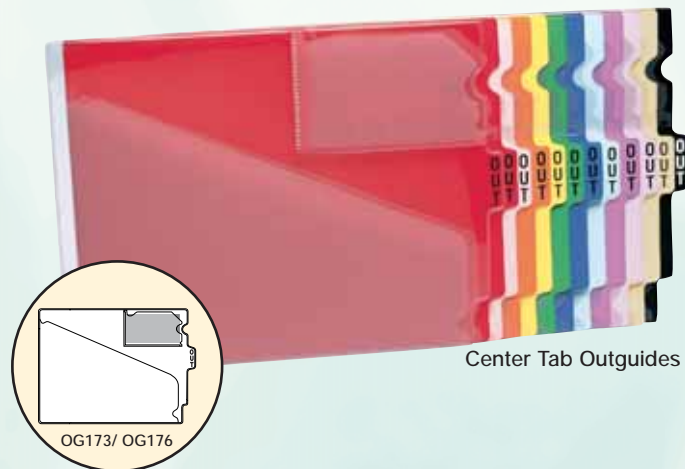

Center Tab Outguides

## Center and Bottom Tab Outguides

The angle-cut of the large pocket and the position of the charge-out pocket, enables the fast placement and retrieval of documents. "OUT" is printed on both sides of the tab. Choose either design, in letter or legal size.

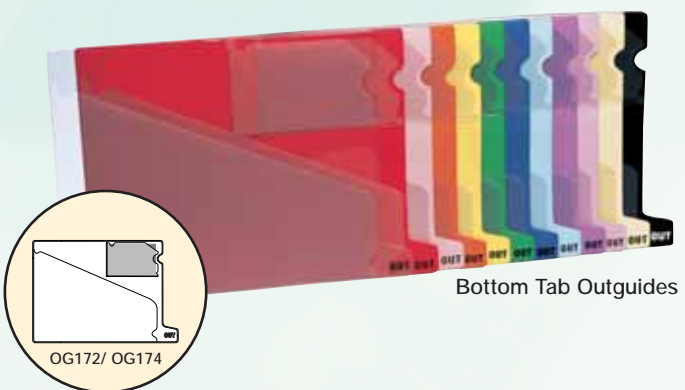

Bottom Tab Outguides

## Full-Pocket Bottom Tab Outguides

The angle-cut pockets speed data access. The oversized charge-out pocket extends over the tab, so you have a triple thickness of material, to prepare these guides for the busiest of office conditions. "OUT" is debossed on the tab.



Large Tab Outguides

## Letter and Legal Outguides

Item No.	Fits Shelving	Tab	Size w/ Tab	Qty/Pk	Lb/Pk
OG173	Letter	Center	12.75 x 9.5	50	8
OG176	Legal	Center	15.75 x 9.5	50	10
OG178	Letter	Bottom	13 x 9.5	25	4
OG179	Legal	Bottom	16 x 9.5	25	5
OG174	Letter	Bottom	13 x 9.5	50	8
OG172	Legal	Bottom	16 x 9.5	50	10
OG171	Letter	Large Tab	13.25 x 9	100	16

OG176 stocked only in red, yellow, and blue.  
OG172 and OG179 stocked only in red.

- Red
- Purple
- Clear
- Orange
- Lt. Blue
- Black
- Green
- Lavender
- Yellow
- Blue
- Pink
- Manila



Full Pocket Bottom Tab Outguides

## Large Tab Letter Outguide

The larger tab makes this design the most popular outguide for heavy-duty performance. "OUT" is debossed on the tab.

# OUTGUIDES

## Economy Outguide

These cost-efficient performers are the choice when a full pocket isn't necessary. The open 3" x 5.5" pocket makes it easy to insert or remove charge-out slips quickly. "OUT" is clearly printed on both sides of the rigid vinyl guides.

### Four Stock Sizes

Item No.	Fits	Size	Qty/Pk	Lb/Pk
OG610	Letter	4 x 13	50	3
OG1144	Mid-Size	4 x 15	50	5
OG615	Legal	4 x 16	50	5
OG600	X-Ray	4 x 20	50	6

OG600, OG1144, and OG615 stocked only in red.

Item No.	Fits	Size	Qty/Pk	Lb/Pk
OG610-ST	Letter	4 x 13	50	3

Assortment includes: 10 each of Red, Orange, Green, Blue and Yellow.



- Red
- Orange
- Green
- Blue
- Yellow

## Low Height Outguide

This unique outguide, constructed of rigid vinyl works well with oversized files. Two resilient, suede clear pockets with stress relief contours make data very accessible. "OUT" is clearly stamped on both sides of the tab.

### Half The Height - All The Features

Item No.	Size w/ Tab	Qty/Pk	Lb/Pk
OG1101	6.5 x 13.75	50	5

- Red
- Orange
- Green
- Blue
- Yellow

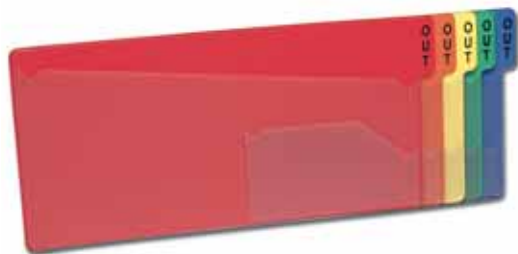

## Top Tab Drawer-Style Outguide

The tab position on this guide works well with top tab file folders in open shelf filing, as well as standard drawer filing. The position of the smaller pocket allows the charge-out slip to be inserted or checked, while leaving the guide in position.

### Works In Open Shelf Filing Too

Item No.	Fits	Size w/ Tab	Qty/Pk	Lb/Pk
OG181	Letter	10 x 11.75	25	4
OG182	Legal	10 x 14.75	25	5

- Red

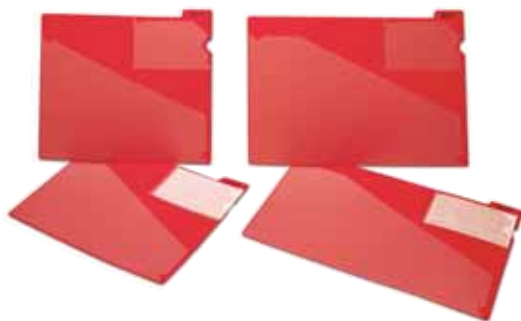

## New! Eye Care Outguide

An outguide specifically designed for the half size files in use at eye care centers across the country. The rigid vinyl guide is printed with OUT on both sides of the tab.

### For Eye Care Centers

Item No.	Size w/ Tab	Qty/Pk	Lb/Pk
OG1146	9.5 x 6	50	5

- Red



# OUTGUIDES



- Red
- Yellow
- Green
- Blue
- Purple

## Heavyweight X-Ray Outguide

These "heavy duty" X-Ray outguides can easily handle the rigors of the most demanding departments. The guides use a rigid die-cut board wrapped with colored vinyl. Suede clear pockets finish the welded construction. Colors may represent a department, doctor, date, etc.

### The Heavyweight Champion

Item No.	Tab Style	Size w/ Tab	Qty/Pk	Lb/Pk
OG160	Top	9.5 x 21	25	15
OG540	Bottom	9.5 x 21	25	17

Orange, Pink, and White In Limited Inventory. Check For Availability.



- Red

## Lightweight X-Ray Outguide

The full-featured designs provide an economical alternative to our heavy-weight guides. The 24 gauge rigid vinyl replaces the die-cut board and soft vinyl construction. This X-Ray outguide provides the durability needed for most radiology file rooms.

### Sturdy and Economical

Item No.	Tab Style	Size w/ Tab	Qty/Pk	Lb/Pk
OG165	Top	9.5 x 21	50	17
OG545	Bottom	9.5 x 21	50	17

## Economy X-Ray Outguide

This cost-efficient performer is the choice when a full pocket isn't necessary. "OUT" is clearly printed on both sides. The 3" x 5.5" pocket is sealed along the back and bottom to allow much easier placement and removal of the charge-out slip.

### When You Don't Need A Full Pocket

Item No.	Fits	Size	Qty/Pk	Lb/Pk
OG600	X-Ray	4 x 20	50	5.3

- Red

## Charge-Out Slips

These simple 3" x 5" forms provide written records to control borrowed files. Slips are inserted into smaller pocket of outguides. Choose padded singles or two-part carbonless.

### Written Records Made Easy

Item No.	Type	Size	Qty/Pk	Lb/Pk
MSC177	Standard	3 x 5	500	.94
MSC177-2	Carbonless	3 x 5	500	1.3

- White





# CUSTOM FILEGUIDES

**Organization and efficiency...** they are your specialty. The integrity of your filing system is critical. Even with all of our in-stock outguide designs from which to choose, your particular requirements may call for something a little different. Perhaps you need a slightly larger guide, a variation to a pocket position or a truly unique design. You don't have to settle for something that really doesn't do the job. We design and produce custom guides all the time. Speak with your distributor. Together we'll come up with the product that really does work for you, at a price that makes sense.

## Out Guides

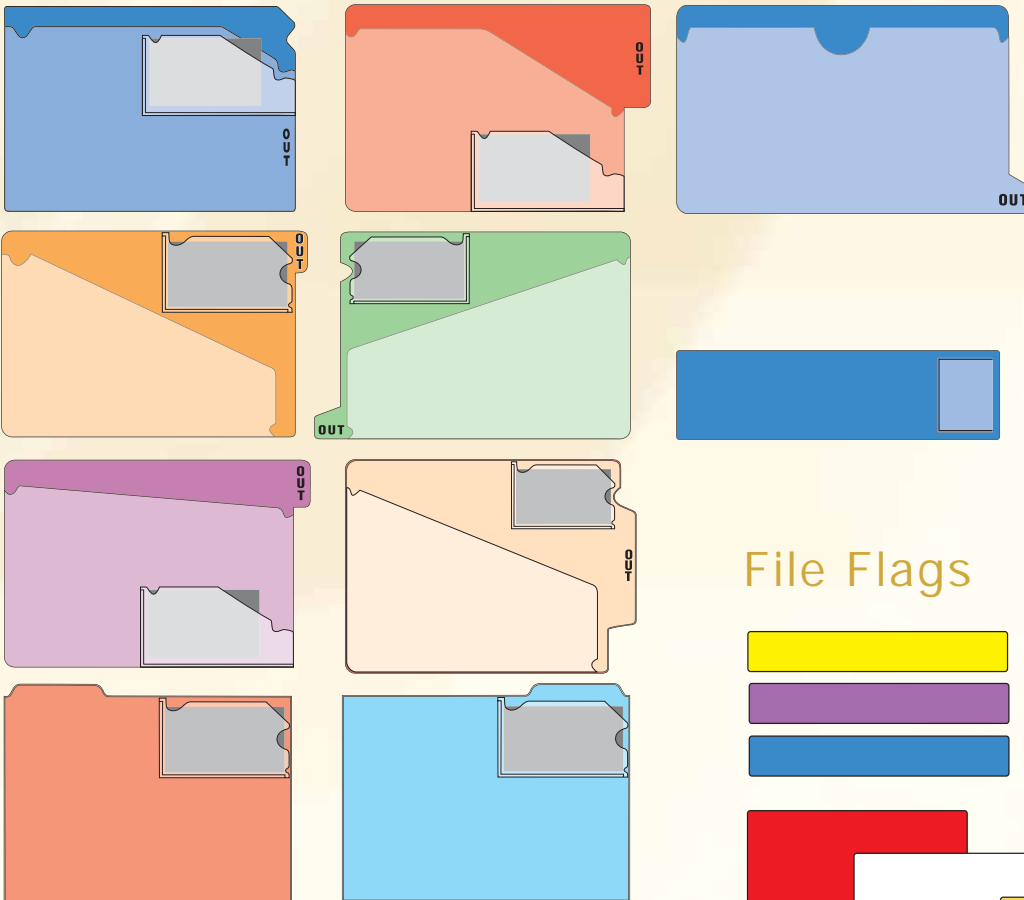

*Here's a few illustrations of some designs we've made for others. We have tooling for many other designs as well. If our existing tooling can work for your application, delivery is faster and your price is lower. Again, talk to your distributor.*

## File Flags



## File Guides

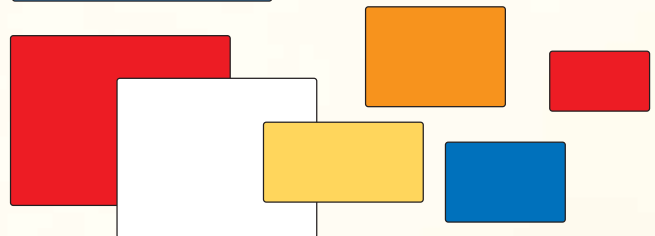

## Shelf Guides

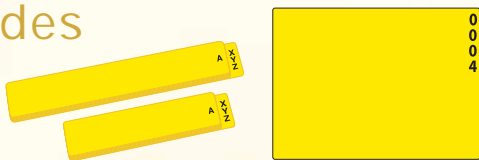

Sometimes a simple divider or flag can improve filing efficiency dramatically. When you measure the cost against productivity gains and perhaps customer satisfaction, it's a 'no-brainer'. Think of the applications... a flag in a folder to signify work to be done... a guide on a shelf to divide categories... an index to find files faster. You choose the size, color and quantity and tell your distributor about any special imprinting.

# SHELF GUIDES



**Personnel move quickly** to the proper file as these visual indexes help to make re-filing more accurate. Use them in either left or right-hand aisles of open shelf filing systems. You can't miss the 24 gauge, bright yellow vinyl guides with large black characters printed on both sides. The Blank guides have clear pockets on both sides and include insert cards.

## Alphabet Guides

Item No.	Size	Qty/Pk	Lb/Pk
FGD580 (X-Ray)	4 x 21	25	2.7
FGD590 (Letter)	4 x 14.5	25	2
FGD591 (Legal)	4 x 17.5	25	3

## Numbered Guides

Item No.	Size	Qty/Pk	Lb/Pk
FGD530 (X-Ray)	4 x 21	100	9.8
FGD570 (Letter)	4 x 14.5	100	8
FGD571 (Legal)	4 x 17.5	100	9

## Blank Guides

Item No.	Size	Qty/Pk	Lb/Pk
FGD790 (X-Ray)	4 x 21	25	2.8
FGD780 (Letter)	4 x 14.5	25	2
FGD781 (Legal)	4 x 17.5	25	3

● Yellow



**FREE**  
Cut To Any Length

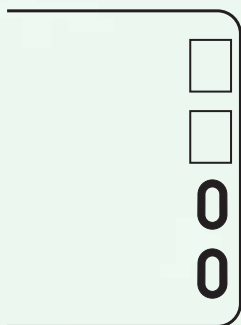

Top two digits depend on number of divisions desired. Bottom two digits are 00-99 on all sets.

### 400 Division Set

Top Numbers are 00, 25, 50, & 75

### 500 Division Set

Top Numbers are 00, 20, 40, 60, & 80

### 1000 Division Set

Top Numbers are 00, 10, 20, 30, 40, 50, 60, 70, 80, & 90

## Multi-Division Numbered Guides

### 400 Division Set (4 Sets of 100)

Item No.	Size	Qty/Pk	Lb/Pk
FGD530-4 (X-Ray)	4 x 21	400	40
FGD570-4 (Letter)	4 x 14.5	400	32
FGD571-4 (Legal)	4 x 17.5	400	36

### 500 Division Set (5 Sets of 100)

Item No.	Size	Qty/Pk	Lb/Pk
FGD530-5 (X-Ray)	4 x 21	500	50
FGD570-5 (Letter)	4 x 14.5	500	40
FGD571-5 (Legal)	4 x 17.5	500	45

### 1000 Division Set (10 Sets of 100)

Item No.	Size	Qty/Pk	Lb/Pk
FGD530-10 (X-Ray)	4 x 21	1000	100
FGD570-10 (Letter)	4 x 14.5	1000	80
FGD571-10 (Legal)	4 x 17.5	1000	90

● Yellow

# FOLDERS

## Poly End Tab Folders

These end tab folders, made of resilient polypropylene, keep your important files neatly organized and protected. The brightly colored wipe-clean material stands out in file rows to increase filing efficiency. Tabs are scored for label positioning. Also available with fasteners in positions 1 and 3 or in custom positions as shown below.

Much More Durable Than Paper

Item No.	Size	Qty/Pk	Lb/Pk
FLD004	12.25 x 9.5	25	3
FLD044 (w/ Fasteners)	12.25 x 9.5	25	4

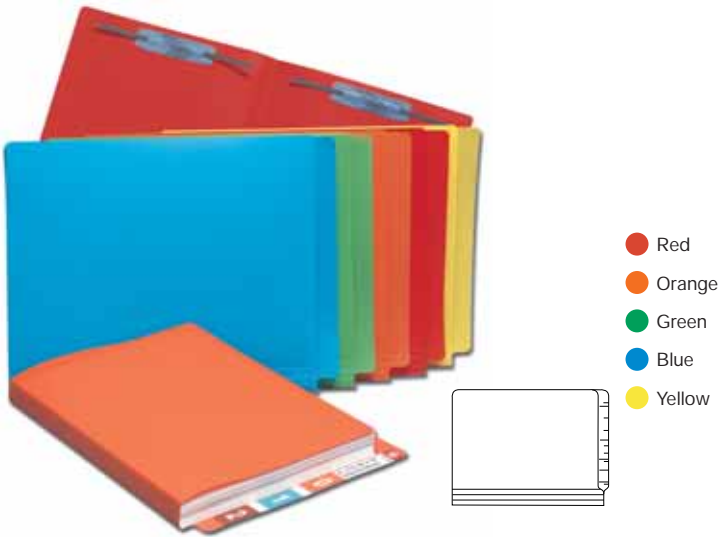

## Poly Top Tab Folders

Paper can't measure up to the long-lasting quality of these durable, polypropylene file folders. The scored front panel accommodates larger files. Solid colors packed three positions per carton. Adhesive labels are included.

Top Tab File Folders - Letter or Legal Sizes

Item No.	Style	Size	Qty/Pk	Lb/Pk
FLD011	Letter	11.75 x 9.5	25	3
FLD012	Legal	14.75 x 9.5	25	4

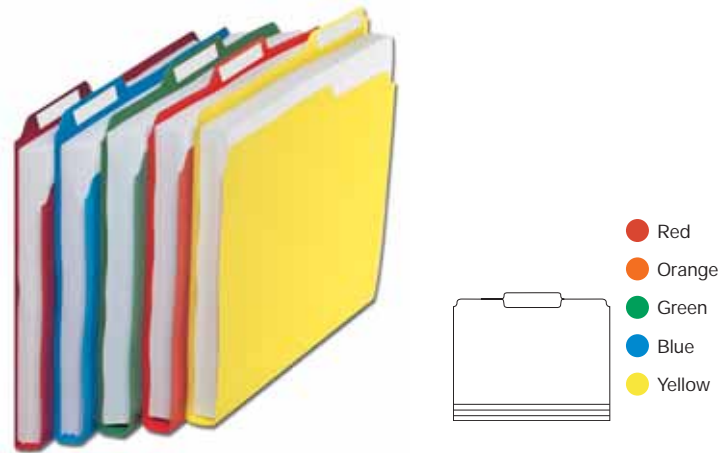

## Custom Fasteners

You can have fasteners attached to our poly folders in any of eight locations.

*Minimum order of 1000 fasteners. Talk to your representative for more details.*

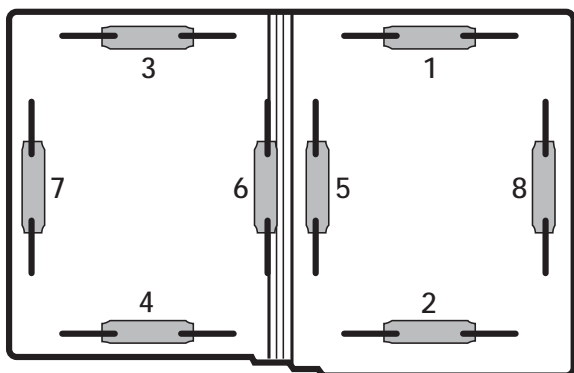

FLD044

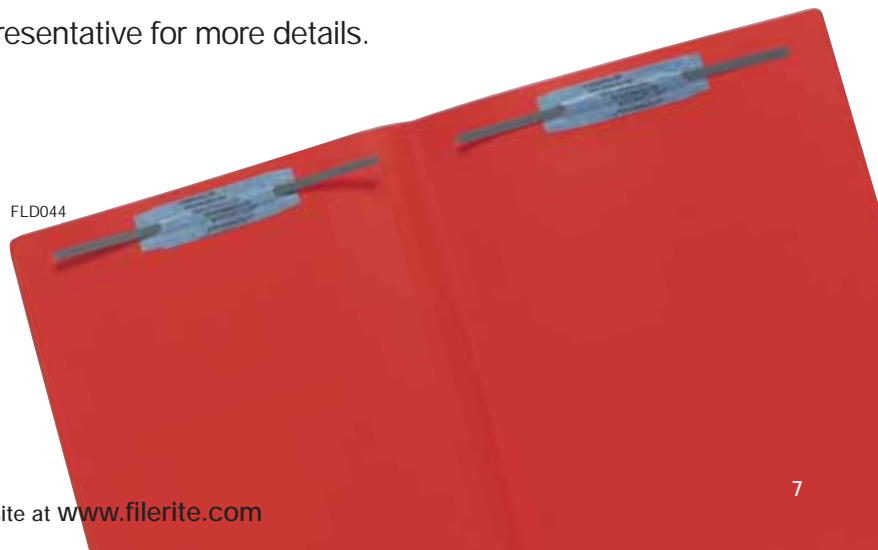

# ORGANIZERS

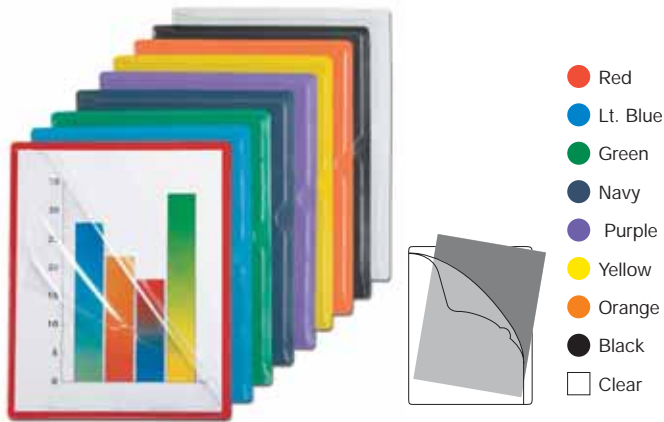

- Red
- Lt. Blue
- Green
- Navy
- Purple
- Yellow
- Orange
- Black
- Clear

## Docu-Mate

You'll be amazed how quickly the crystal-clear front and the color-coded back helps you find your papers and projects. The strong but flexible material is made with a copy-guard formulation to prevent photocopy transfer.

### Docu-Mate | Letter Size

Item No.	Size	Qty/Pk	Lb/Pk
ORG5005	11.75 x 9.25	25	3

### Letter Size | Assortment Pack

Item No.	Size	Qty/Pk	Lb/Pk
ORG5005-ST	11.75 x 9.25	25	3

Assortment includes: 5 each of Red, Light Blue, Green, Yellow and Orange.



- Red
- Lt. Blue
- Green
- Yellow

## File-Mate

The only thing that could make the 'Documate' better... the 1/3 cut tabs make it easy to identify your files even in a stack of 'mates'. Labels included. The strong but flexible material is made with a copy-guard formulation to prevent photocopy transfer.

### File-Mate | Letter Size

Item No.	Size	Qty/Pk	Lb/Pk
ORG5023-ST	11.75 x 9.25	24	3

Assortment includes: 2 of each color in each position.



- Red
- Navy
- Clear

## Media-Mate

Your e-media is secure in the Media Mate. This 'Documate' has a velcro closure on the front pocket to hold micro-cassettes, audio cassettes, diskettes, zip disks, CDs or DVDs. Plus, there are pockets for business and ID cards (included) and room for a good sized file. A great organizer for presentations. The strong but flexible material is made with a copy-guard formulation to prevent photocopy transfer.

### Media-Mate | Letter Size

Item No.	Size	Qty/Pk	Lb/Pk
ORG5017	11.75 x 9.25	10	1.3



# ORGANIZERS



- Red
- Orange
- Green
- Blue
- Yellow

## Poly File Jackets

Your documents are safe, organized and easy to reach in these strong polypropylene jackets. The non-glare transparent front lets you see the jacket contents, while the thumb-notch design and adhesive labels allow for quick retrieval. Archival-safe, the jackets will not transfer photocopy toner. Choose either letter or legal size in five vibrant colors.

### Poly File Jackets | Letter or Legal Sizes

Item No.	Style	Size	Qty/Pk	Lb/Pk
ORG5007	Ltr	11.75 x 9.5	25	3
ORG5008	Lgl	14.75 x 9.5	25	4



Expands to hold up to 300 paper sheets.

## Expanding File Jackets

You can hold up to 300 sheets of paper in the gusseted design of these tough, long-lasting poly jackets. The non-glare, clear front pocket folds down for quick access, and makes it easy to see the contents.

### Expanding File Jacket | Letter Size

Item No.	Size	Qty/Pk	Lb/Pk
ORG5006	11.75 x 9.5 x 2	10	2

### Letter Size | Assortment Pack

Item No.	Size	Qty/Pk	Lb/Pk
ORG5006-ST	11.75 x 9.5 x 2	10	2

Assortment includes: 2 of each color in each position.



- Red

## Mid-Size File Pocket

This oversized organizer will hold end-tab letter-size folders and other larger files. Originally developed for Diagnostic Imaging, the double pocket design is a versatile file manager. The file pocket has a rigid back and suede clear pockets.

### Protect Your Patient Files

Item No.	Size	Qty/Pk	Lb/Pk
BCC550	13.75 x 10.5	25	5.8

# ORGANIZERS



- Clear
- Smoke
- Yellow
- Purple
- Blue
- Red

## String & Button Envelopes

Six see-through colors create an exciting look to presentations and organization of projects. The transparent material lets you easily identify contents. Expands to hold up to 200 sheets. Durable polypropylene outlasts paper envelopes. The string and button closure is fast and efficient. Available in letter and legal sizes, open short or long side.

### Select The Style That Fits The Project

Item No.	Opens	Size	Qty/Pk	Lb/Pk
ORG5010 Ltr	Short	9.75 x 11.75	24	3
ORG5011 Lgl	Short	10 x 14.25	24	4
ORG5012 Ltr	Long	13 x 9.75	24	3
ORG5013 Lgl	Long	14.25 x 10.5	24	4



**New Sizes!**

## Mesh Carrying Bag

These sturdy, quality-designed see-through mesh bags provide easy, convenient transportability for your files and papers. Slip a plastic lock (see page 11) through the zipper and end loop for enhanced security.

### Carry With Confidence

Item No.	Size	Qty/Pk	Lb/Pk
BCC001	16 x 12	10	3
BCC005	14 x 10.5	10	2.5
BCC006	12 x 9	10	2

- Clear



## Expanding Portfolio

Many times more durable than paper, this polypropylene expanding portfolio securely holds your letter or legal size documents. The sewn pouch expands five inches to hold the largest of files. An elastic closure keeps files secure.

### Great For Legal Files

Item No.	Size	Qty/Pk	Lb/Pk
ORG5009	10 x 15.25 x 5	5	10

- Black



## New! CD Saver

Store compact disks in file folders or create separate files with these smooth, durable polypropylene sleeves. Disks stay clean and organized, and a tuck-in flap holds CD's more securely than an open pocket. Sleeves come with self-stick labels for built-in index tabs.

### Sleeve Protectors For Your E-Media

- Red
- Lt. Blue
- Yellow
- Green
- Clear

Item No.	Style	Size	Qty/Pk	Lb/Pk
ENV120	Clear	5 x 5	50	.94

### CD Saver | Assorted Pack

Item No.	Style	Size	Qty/Pk	Lb/Pk
ENV121	Assorted	5 x 5	50	.94

Assortment includes: 10 of each color.

# PRIVACY ENVELOPES



**HIPAA SAFE!**

**New!**

## Confidential Envelopes

Great for sending documents for review and return. Double glue strips and double perforations at the top of the envelope let you seal it, open it, then reseal it again for another use. This incredibly strong tri-extruded polyolefin envelope is opaque for confidentiality and is waterproof and lightweight for reduced postage costs.

### Standard, Non-Imprinted Confidential Envelopes | Open Short Side

Item No.	Style	Size	Qty/Pk	Lb/Pk
ENV103R	Letter	10 x 13	100	3.5
ENV159R	X-Ray	15 x 19.75	100	7.5

### Oversized, Imprinted Confidential Envelopes | Open Long Side

Item No.	Style	Size	Qty/Pk	Lb/Pk
EPP160R	Letter	14.5 x 11.75	100	5.0
EPP161R	Legal	17.5 x 11.75	100	7.0
EPP162R	X-Ray	20.75 x 17.25	100	9.0

○ White

## Confidential Carrier

Virtually eliminate damaged, lost, misdelivered or "snooped at" files. Oversized and extremely durable, these versatile carriers expand to hold up to 4 inches of files. Use the carriers over and over...their super-strong Armor Shell material is washable and waterproof. Nylon zippers provide convenient access to the file. Choose from the security accessories shown below to ensure confidentiality.

### Standard, Imprinted Confidential Carriers

Item No.	Style	Size	Qty/Pk	Lb/Pk
ENV001	Letter/Legal	16.5 x 12.5	5	2.3
ENV003	X-Ray	22 x 19	5	3.8

### Expandable, Imprinted Confidential Carriers with Straps

ENV004	Letter/Legal	17 x 11 x 4.5	5	5.0
ENV005	X-Ray	22 x 17 x 4.5	5	6.0

Black In Limited Inventory. Check For Availability.



- Red
- Orange
- Yellow
- Blue

**HIPAA SAFE!**

**New!**

## Security Accessories

Our plastic pull tight and pre-numbered seals, used with our routing slips, assures the integrity of private and sensitive materials.

### Security Accessories

Item No.	Style	Color	Qty/Pk	Lb/Pk
MSC103	Standard Lock	White	250	.09
MSC014	Numbered Lock	Red	50	.06
MSC015	Routing Slip	White	250	.69

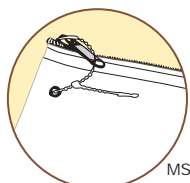

MSC103

Standard Lock

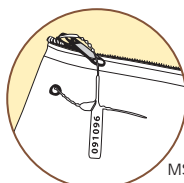

MSC014

Numbered Lock

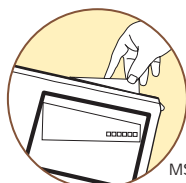

MSC015

Routing Slip

Visit our website at [www.filerite.com](http://www.filerite.com)



# STICK ON POCKETS

## Poly Pockets

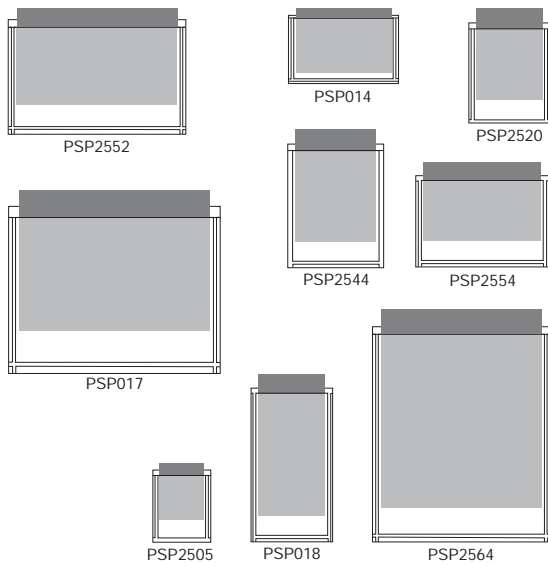

Put things where you want them... these adhesive-backed pockets simplify the filing and organizing of I.D. cards, photos, microfiche, lab cards and more. Just peel them off and stick them on. No more loose or lost items. With so many sizes and styles to choose from, you can't go wrong. If you need a special size, ask your distributor about custom options.

## Poly Pockets

The resilient 5 mil heavy-duty pockets have a clear back for read-through instructions. Nine sizes to fit most applications.

### Stick-On Simplicity

Item No.	Overall Size	Pocket Size	Qty/Pk	Lb/Pk
PSP2505	3 x 3.75	2.5 x 3.25	100	.5
PSP2520	4.25 x 5.5	3.75 x 5	100	1.1
PSP014	5.75 x 3.5	5.25 x 3	100	1.1
PSP2544	5 x 6.5	4.5 x 6	100	1.4
PSP2554	7 x 4.75	6.5 x 4.25	100	1.4
PSP018	4.25 x 8	3.75 x 7.5	100	1.6
PSP2552	9.25 x 6	8.75 x 5.5	100	2.3
PSP2564	9.25 x 11.25	8.75 x 10.75	100	4.6
PSP017	11 x 9	10.5 x 8.5	100	4.6

Clear

## Lock-It Pockets



## Lock-It Pockets

Your CD's, diskettes, and just about any smaller items or documents can be safely stored in these sturdy zip-lock self-adhesive poly pockets. View the contents for easy identification.

### ZipLock Stick-On Poly Pocket

Item No.	Overall Size	Pocket Size	Qty/Pk	Lb/Pk
PSP007	5.5 x 6.25	5 x 5.25	100	1.6
PSP019	6.5 x 10	6 x 9	100	2.6
PSP031	4 x 4.75	3.5 x 4.25	100	.76

Clear

## Place-Rite Vinyl Pockets

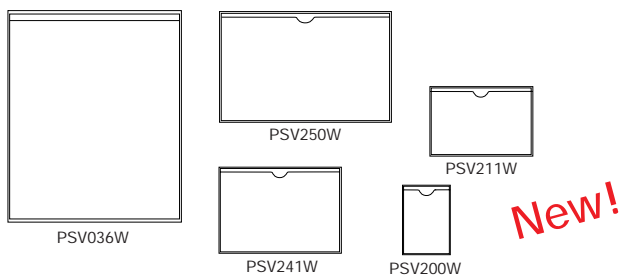

## Place-Rite Vinyl Pockets

The 8 gauge non-glare vinyl front has a taffeta embossing to resist image transfer. The adhesive back is a soft white for a clean professional look.

### Easy to Apply Vinyl

Item No.	Overall Size	Qty/Pk	Lb/Pk
PSV200WC	2.5 x 3.75	100	1
PSV211WC	5.5 x 3.5	100	2
PSV241WC	6.5 x 4.5	100	2
PSV250WC	9 x 5.75	100	3
PSV036WH	9 x 11.5	100	4

White Back/  
Non-Glare Front





# ENVELOPES



**New!**

## Policy and Brochure Jackets

Show off promotional literature in these transparent, attractive jackets. The stitched-sealed edges keep them looking good even after dozens of uses. Made of long-lasting vinyl.

Great For Insurance Brochures

Item No.	Size	Style	Qty/Pk	Lb/Pk
ENV122	4.75 x 9.75	Single Pocket	25	.5
ENV123	4.5 x 9.38	Business Card	25	.5
ENV124	4.5 x 9.38	Double Pocket	25	1

Clear



ENV122  
Single Pocket



ENV123  
Single Pocket/ Business Card



ENV124  
Double Pocket/ Center-Loading

**New Sizes!**

## Thumb-Notch Envelopes

These crystal clear vinyl jacket envelopes are ideal for storing your important documents. The notched top makes it easy to retrieve the contents.

Accessible Safekeeping

Item No.	Insert Size	Qty/Pk	Lb/Pk
ENV043	4 x 6	50	2
ENV077	5 x 8	50	2
ENV045	6 x 9	50	2
ENV046	8.5 x 11	50	4
ENV047	9 x 12	50	4
ENV076	11 x 14	50	4

Clear



## Hang-Hole Envelopes

Great for job instructions, special notes, price tags and other documents. These heavy duty vinyl envelopes feature a clear front for easy viewing.

Put Your Documents Within Easy Reach

Item No.	Pocket Size	Opening	Qty/Pk	Lb/Pk
ENV024	4 x 6	Short	100	3
ENV026	6 x 9	Short	100	6
ENV028	11.5 x 9	Long	100	11
ENV070	9.5 x 11	Short	100	11
ENV030	12.5 x 9	Long	100	11
ENV027	9.5 x 12	Short	100	11
ENV069	11.5 x 14	Short	100	16
ENV031	17.5 x 11	Long	100	18
ENV029	11.5 x 17	Short	100	18

Clear



# ENVELOPES



## Heavy Duty Stick-On Envelopes

These handy envelopes can be used on storage bins, boxes, walls, doors, equipment or any other flat surface. Just peel off the backing and stick the envelope in the desired place. Made of heavy-duty crystal-clear vinyl to hold up under adverse conditions.

Stick Anywhere And Everywhere

Item No.	Overall Size	Fits	Qty/Pk	Lb/Pk
PSV031	4.5 x 6.5	4 x 6	50	2
PSV034	6 x 9	5.5 x 8.5	50	3
PSV036	9 x 11.5	8.5 x 11	50	5
PSV037	9.5 x 12.5	9 x 12	50	6
PSV038	10 x 12	9.5 x 11.5	50	6
PSV067	4.5 x 4.75	3.5 Diskette	50	2
PSV069	5.25 x 5.25	CD/DVD	100	5
PSV070	3.5 x 2.13	I.D. Cards	50	4

Clear

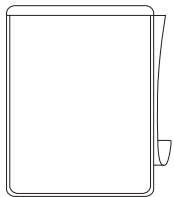

PSV038

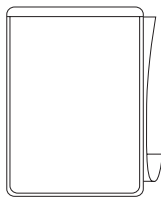

PSV037

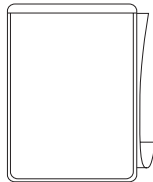

PSV036

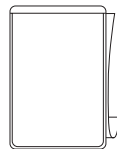

PSV034

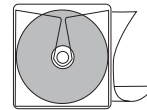

PSV069



PSV067



PSV031



PSV070

**New  
Sizes!**

## Zipper Lock Envelopes

These sturdy vinyl storage and organizing bags provide a dependable zipper seal that keeps documents, samples and other important items secured inside.

The Safe Way To Store It

Item No.	Overall Size	Pocket Size	Qty/Pk	Lb/Pk
ENV062	4 x 6	3.75 x 5.25	100	3
ENV064	6 x 9	5.75 x 8.25	100	5
ENV066	9.25 x 12	9 x 11.25	100	9
ENV067	10 x 13	9.75 x 12.25	100	9
ENV068	12 x 15	11.75 x 14.25	100	10

Clear



ENV062



ENV064



ENV066



ENV067

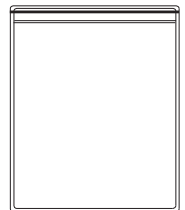

ENV068

# ENVELOPES

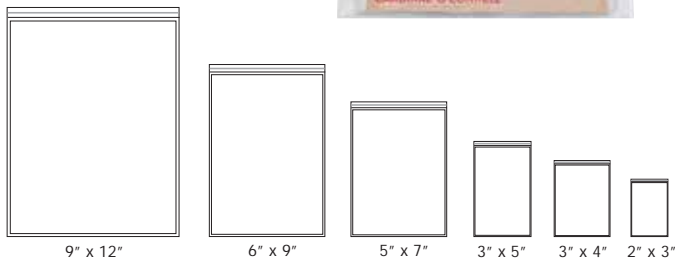

## Press-N-Seal Poly Bags

The Press-N-Seal top keeps contents in and dust, dirt and moisture out. An assortment of sizes make these versatile bags great for storing or organizing things from small parts to large papers. Made of clear polyethylene, contents can be seen at a glance.

### Seal It Up

Item No.	Size	Qty/Pk	Lb/Pk
ENV091-2	2 x 3	1000	3
ENV092-2	3 x 4	1000	4
ENV093-2	3 x 5	1000	4
ENV095-2	5 x 7	1000	7
ENV097-2	6 x 9	1000	10
ENV098-2	9 x 12	1000	17

Clear

**New Sizes!**

## Sewn Envelopes

These heavy-duty, 6.5 gauge clear polypropylene job ticket holders make it easy to view the contents at a glance. And your photocopy toner won't transfer to the safe polypropylene. Sewn with sturdy black leatherette binding for added strength. Use them for work orders, production schedules, special instructions, price tags, etc.

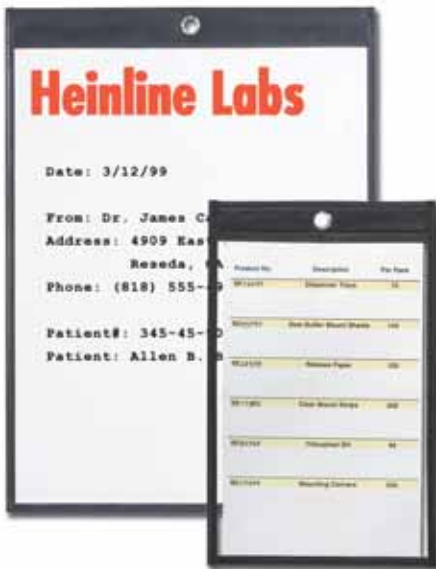

Clear

### PolyPro Protection

Item No.	Size	Qty/Pk	Lb/Pk
ENV052	4.25 x 6.25	50	3
ENV053	6.25 x 9.25	50	4
ENV054	8.75 x 11.25	50	5
ENV055	9.25 x 12.25	50	6
ENV078	11.25 x 14.25	50	7
ENV057	11.25 x 17.25	50	8
ENV060	14.25 x 17.25	50	9

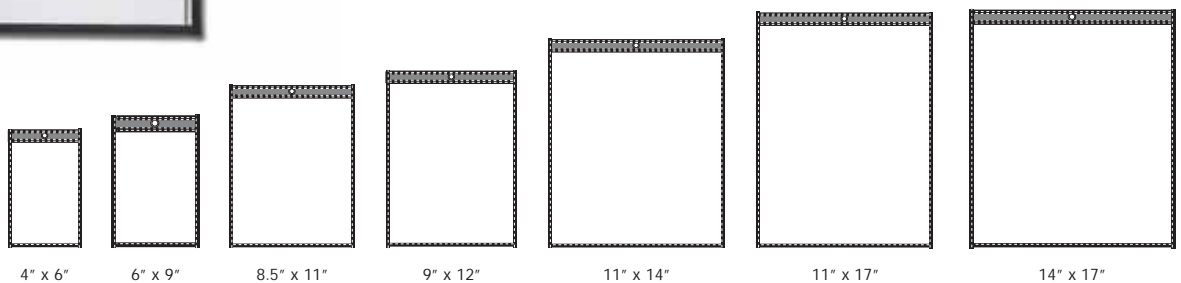

# POLY INDEXES

## Flexibility with Durability for Efficient Information Management.

**Indexes** offer a brilliant solution for presentations, employee handbooks, training manuals and catalogs as well as hospital charts and medical records.

- Custom, printed tabs let you organize information for quick reference.
- Tough poly indexes help lift documents over the rings to reduce stress while minimizing tear-out.
- Made from tear-resistant 16 gauge poly, indexes will hold up to rough use year after year...guaranteed.
- Poly surface easily wipes clean and will help protect documents from spills and dirt.
- Long or short side indexes ideal for any application.
- Sets are collated and poly bagged.

- Shown with optional Flag Sheet and Pull-Out Alerts.

**All Poly Index sets** are produced per your order. You choose tab sizes, positions, imprints and colors. Ask your distributor for an easy order form.

Available in 16 vibrant colors

- |                               |                                 |
|-------------------------------|---------------------------------|
| <input type="radio"/> White   | <input type="radio"/> Lavender  |
| <input type="radio"/> Ivory   | <input type="radio"/> Mauve     |
| <input type="radio"/> Gray    | <input type="radio"/> Blue      |
| <input type="radio"/> Gold    | <input type="radio"/> Lt. Blue  |
| <input type="radio"/> Yellow  | <input type="radio"/> Teal      |
| <input type="radio"/> Orange  | <input type="radio"/> Lt. Green |
| <input type="radio"/> Apricot | <input type="radio"/> Green     |
| <input type="radio"/> Red     | <input type="radio"/> Pink      |

The image shows a 'File Rite Custom Poly Index - Easy Order Form'. It includes a table for selecting index positions (1-13) and colors, and a section for 'Personalization' with fields for name, address, and phone number. There are also checkboxes for 'Printed Index' and 'Personalized Index'.





# BINDERS



## Poly Binders

These economical, space-saving binders are made from lightweight, stain and crack-resistant polyethylene with an attractive textured grain. Sturdy, round metal rings secure your documents in place.

### A Binder Sized For Every Job

Item No.	Size	Ring	Holds	Qty/Pk	Lb/Pk
BND005	9.69 x 11.63	.5	100 Pgs.	12	4
BND006	9.69 x 11.63	1	220 Pgs.	12	6
BND007	9.69 x 11.63	1.5	320 Pgs.	12	6



- Burgundy
- Red
- Black
- Blue
- Lt. Blue

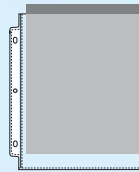

FLM015

## Poly Sheet Protectors

Protect and display your important documents. Tough, medium-weight polypropylene prevents your photocopy images from transferring to the protector.

### Archival Safe, Easy Loading Design

Item No.	Overall Size	Pocket Size	Qty/Pk	Lb/Pk
FLM015	9.13 x 11.25	Letter	100	3

Clear

# FILM & CHART PAGES

**New Sizes!**

## Folder/ Chart Pages

Protect and organize prints, films and documents in these crystal clear vinyl pages. Each is sized at 8.5" x 11" except the FLM025 and FLM040. At 8.75" x 11.5", they hold letter size documents.

Punched To Fit 2.75" Fasteners

Item No.	Holds	Qty/Pk	Lb/Pk
FLM008	8 - 4 x 5	100	6
FLM024	4 - 5 x 8	100	6
FLM480	2 - 8 x 10	100	6
FLM025	2 - 8.5 x 11	100	6
FLM040	2 - 8.5 x 11	100	6
FLM009	20 - 35mm Slides	100	6

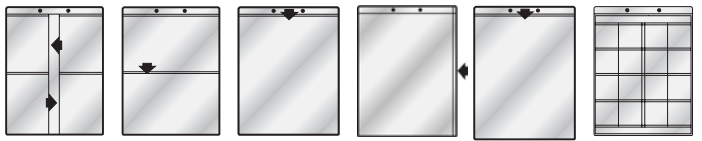

Clear



## Polaroid Film Mounts

Organize your Polaroid prints for easy viewing and filing. The flexible, crystal clear mounts are designed for back-to-back print insertion... doubling capacity. All four styles are sized to hold 3.38" x 4.25" prints. The FLM460 and FLM465 include ID cards.

Now Prints Are Easy To View And File

Item No.	Size	Qty/Pk	Lb/Pk
FLM360	11 x 9.5	100	7
FLM380	9.5 x 7.5	100	4
FLM460	11 x 8.5	100	6
FLM465	11 x 8.5	100	6

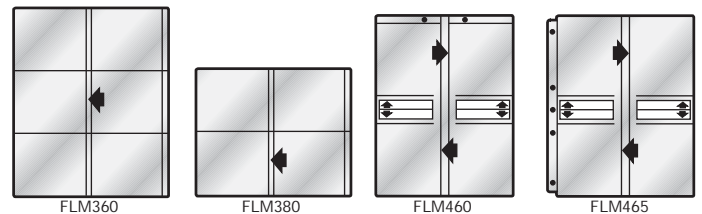

Clear



## Video Print Mounts

These "Print-Safe" mounts are guaranteed to protect your prints from image transfers. Just peel and expose the adhesive on the FLM306, then position it in any file folder. Holds six 110mm wide images. The four pocket FLM304 is sized to hold eight 110mm or 115mm images.

Now Prints Are Easy To View And File

Item No.	Size	Qty/Pk	Lb/Pk
FLM304	8.5 x 9.63	100	2
FLM306	4.38 x 11	100	1

Clear

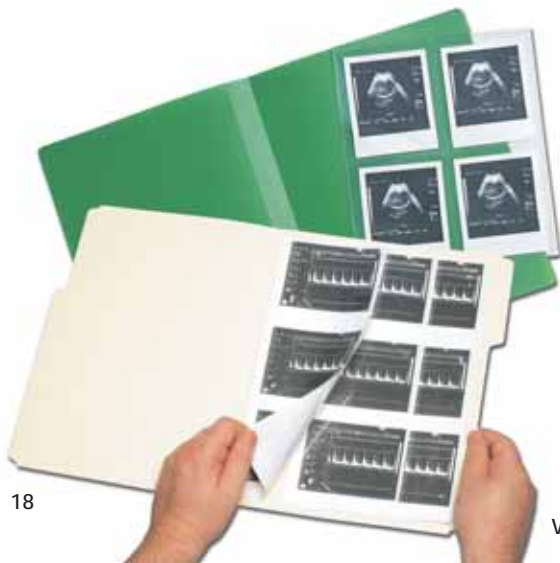

# FILM MOUNTS

**Neat and simple...** No dirt, no scratches, no fingerprints...no messy adhesives to smear your crucial images. These crystal clear mounts simplify the handling of the cut and roll film produced by 100mm cut film and 105mm roll film cameras. Films are easily rearranged if necessary. The 14" x 17" mounts snap easily into place on the illuminator for hassle-free viewing.



FLM250

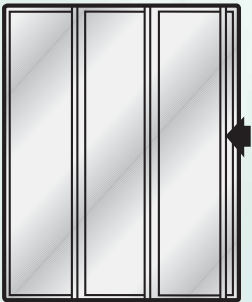

FLM050

Open the entire length of each sleeve.

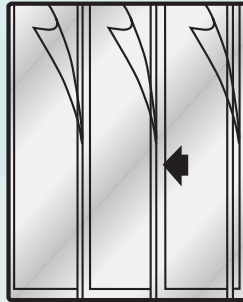

FLM070

Open on the top edge as well as the long side. Flap adds security.

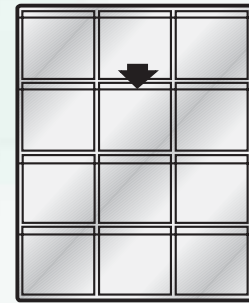

FLM250

Top loading pockets.



FLM240

Our Best Seller

Mounts available in 100mm and 4 styles of 105mm.

Item No.	Film Type	Loading	Qty/Pk	Lb/Pk
FLM250	100mm	Top Load	100	14
FLM240	105mm	End Load	100	14
FLM080	105mm	Zip Load	100	15
FLM050	105mm	Side Load	100	15
FLM070	105mm	Flap Load	100	14



Mounting 105mm film in the FLM080 "Zip Load" is as easy as 123...

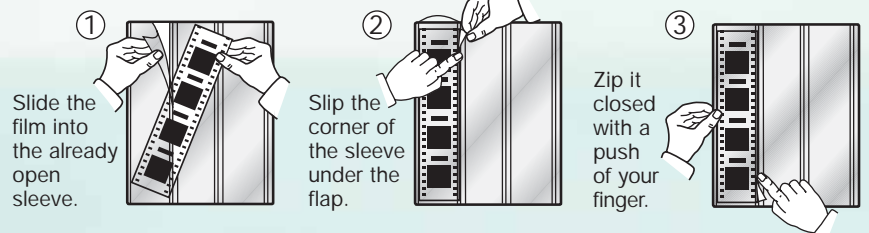

The film is locked in place and ready for viewing.

# X-RAY FILM CARRIERS



- Red
- Yellow
- Green
- Blue
- Purple

## Radiology Standard

This department workhorse features a welded rivet design, double layers of material at the top of the pockets and a heavy-duty die-cut board to add to the overall strength. The 9 and 13 inch high suede-clear vinyl pockets are welded to the color-coded vinyl back.

Great For Physician's Office Use

Item No.	Size	Qty/Pk	Lb/Pk
BCC190	14.5 x 21.5	10	10

Orange, Pink, and White in limited inventory. Check for availability.



- Red
- Yellow
- Green
- Blue
- Purple

## Economy Caddy

The most affordable way to transport patient files and x-ray films. This low-priced caddy is available in single and double pocket versions. The double pocket design also comes in a choice of colors.

Our Most Economical Film Carrier

Item No.	Color	Pocket	Size	Qty/Pk	Lb/Pk
BCC150	Clear	Single	14.5 x 19.5	25	8.8
BCC150-2	Clear	Double	14.5 x 19.5	25	12
BCC151-2	See Left	Double	14.5 x 19.5	25	16

Orange, Pink, and White in limited inventory. Check for availability.



- Clear

## Expanding Caddy

You can carry more than 100 14 x 17 inch films in this flexible jacket with expanding sides. The one-piece construction has a seamless base and pre-cut corners. Stress-relieving contours and reinforcing eyelets add life to the resilient material.

A Clear Cut Value With Added Capacity

Item No.	Pocket	Size	Qty/Pk	Lb/Pk
BCC510	Single	15 x 20.5	10	4.4
BCC520	Double	15 x 20.5	10	5.4



- Red
- Yellow
- Green
- Blue
- Purple

## Rite File

The wrap-around design of the pockets turns the force of everyday use against the shear resistance of the rear carrier weld...resulting in a stronger jacket! Color-coded vinyl covers the die-cut board to form a semi-rigid body. The crystal clear pockets are reinforced with a double layer of material at the top for extra strength. Large hand-cuts make it easy to pull out films and files.

Get 2 Clear Pockets Without Giving Up Durability

Item No.	Size	Qty/Pk	Lb/Pk
BCC900	15 x 21.5	10	14

Orange, Pink, and White in limited inventory. Check for availability.



# X-RAY FILM CARRIERS

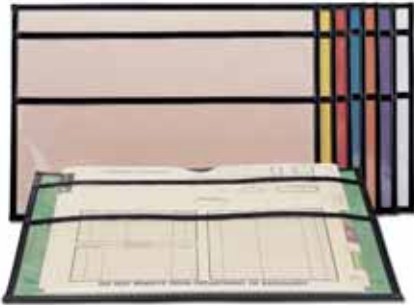

- Red
- Orange
- Yellow
- Green
- Blue
- Purple
- Pink
- White

## Classic Film Carrier

Superior looks and strength make the Classic our most popular film carrier. The color-coded vinyl surrounding the die-cut board is welded to 8.5" and 13" deep crystal clear pockets. Industrial quality nylon-woven binding is sewn on all edges to provide remarkable strength. The classics are built to last, in even the busiest of healthcare facilities.

### Our Strongest, Most Durable Film Carrier

Item No.	Size	Qty/Pk	Lb/Pk
BCC695	15 x 21.5	10	12



Expands a full 1.5" without bending or bulging.

## Expanding Classic Film Carrier

We've taken our distinctive Classic Carrier, with all of its features, and expanded it to hold the largest of patient files. The sides of the larger pocket expand to hold more than 1.5" of films and files, without bending or bulging.

### Same Strength, Same Durability, With Added Capacity

- Red
- Yellow
- Blue

Item No.	Size	Qty/Pk	Lb/Pk
BCC690	15 x 21.5 x 1.5	5	7



The BCC560 expands a full 1.5" without bending or bulging.

## New! Mid-Size Classic Carrier

All of the great features of the Classic Carrier in a down-sized version to hold the smaller sized film procedures. Holds new oversized mammography jackets. The expanding model holds 1.5" of film history.

### File Transport With Class

- Red
- Yellow
- Blue

Item No.	Size	Qty/Pk	Lb/Pk
BCC559	15.25 x 11.75	10	7
BCC560*	15.25 x 11.75 x 1.5	5	7

\* With Expansion

# X-RAY CASES



● Black

## Conference Case

Quality craftsmanship lends a mark of distinction to this classic textured leather-like case...perfect for carrying films and files between home, office and the clinic. Even the largest transport jackets and patient file envelopes fit comfortably into the fully lined carrier. Includes wrap-around, double-direction nylon zippers, two full-width inside pockets, and scuff-resistant feet.

### Conference Case

Item No.	Size	Qty/Pk	Lb/Pk
DB710	17 x 22 x 3	1	4



● Black

## Genuine Leather Transport Case

This rich looking, textured soft leather case is also highly functional for carrying films and files between the home, the office and the clinic. The fully padded case includes wrap-around, smooth pulling nylon zippers, inside and outside pockets, and a detachable strap.

### Transport Case

Item No.	Size	Qty/Pk	Lb/Pk
BCC002	17 x 22 x 3	1	4



**Improved Design!**

● Black

## Expandable Carrying Case

When locks are placed through the security loops and a routing slip is inserted from the inside of the carrier, the integrity of private and sensitive materials is assured. Made of water-resistant nylon and sewn for extra strength, this case expands to a full 6" wide. The case features rigid sides and a velcro closure flap, as well as full width interior pockets and a detachable strap.

### Carrying Case

Item No.	Size	Qty/Pk	Lb/Pk
BCC003	16 x 22 x 6	1	4

### Security Accessories (See Page 11)

Item No.	Style	Color	Qty/Pk	Lb/Pk
MSC103	Standard Lock	White	250	.09
MSC014	Numbered Lock	Red	50	.06
MSC015	Routing Slip	White	250	.69

**HIPAA SAFE!**